

# Installation Instructions

**AURA-6032-RT**

## SUGGESTED TOOLS AND MATERIALS

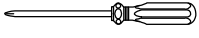

Screwdriver



Level



Drill



Tape Measure

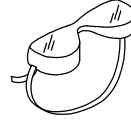

Safety Glasses



Pencil

## PARTS & HAREWARE INCLUDED



Anchor 8x



Screw 8x



Level 1x

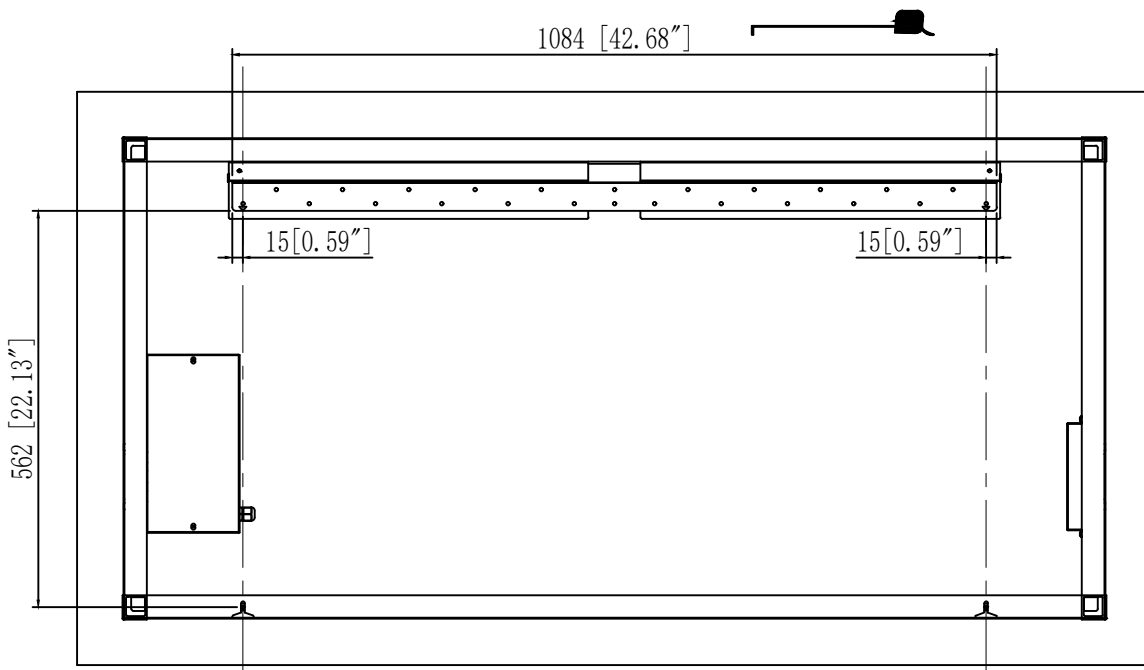
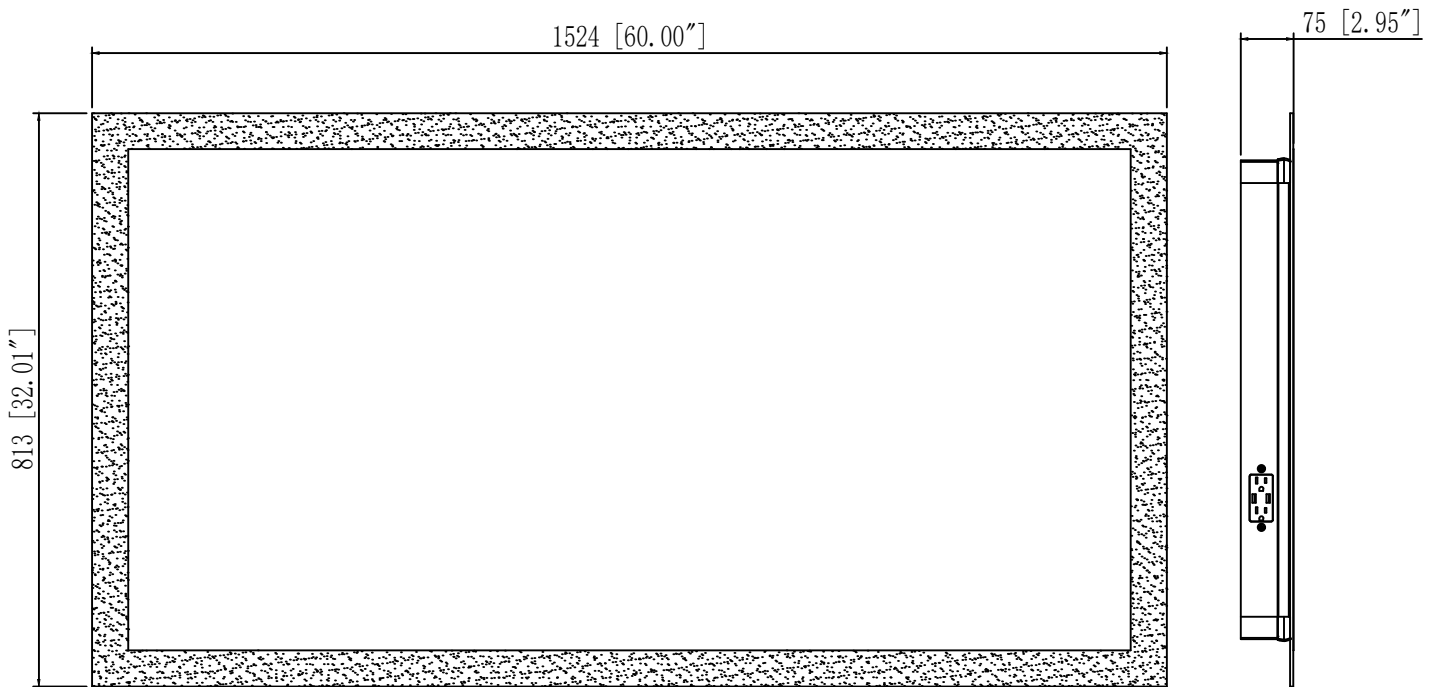

# Installation Instructions

**AURA-6032-RT**

## SUGGESTED TOOLS AND MATERIALS

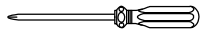

Screwdriver



Level



Drill



Tape Measure

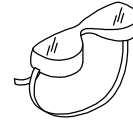

Safety Glasses



Pencil

## PARTS & HAREWARE INCLUDED



Anchor 8x



Screw 8x

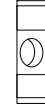

Level 1x

## INSTALLATION INSTRUCTIONS

**1**

1084 [42.68"]  
15 [0.59"] 15 [0.59"]  
562 [22.13"]  
Level  
1.  
2.  
3.  
The bottom screw is positioned with the hanging cleat arrow as the reference

1>Level the hanging cleat with a level ruler and mark the installation hole position of the hanging cleat with a pencil.  
2>The bottom screw positioning is measured based on the hanging cleat edge. The screw position is parallel and centered, and the hanging cleat center is downward. Pay attention! When positioning the bottom screw position, please use a level ruler to level the vertical direction. As shown in the above diagram.  
3>Drill holes.

**2**

Insert the anchors into the wall (Use at least 8 anchors).

**3**

Wall  
min 0.2"  
DETAIL A

Install the hanging cleat into the wall.  
Use 5x45mm screws to hanging cleat to wall (Use at least 6 screws).

**4**

Wiring from light fitting

Neutral Wire	white(N)
Earth (green/yellow)	Green/yellow
Live Wire	black(L)

**5**

1.  
2.  
3.

Hang the mirror onto the wall.

Wall

Wall  
DETAIL A  
DETAIL B